



## MCR100-6 0.8A Sensitive SCR

Rev.A.1.0

### DESCRIPTION:

The MCR100-6 SCR provides high  $dV/dt$  rate with strong resistance to electromagnetic interface. It is especially recommended for use on residual current circuit breaker, straight hair, igniter etc. Complying with UL standards (File ref: E252906). Package TO-92 is RoHS compliant.

### MAIN FEATURES

Symbol	Value	Unit
$I_{T(RMS)}$	0.8	A
$V_{DRM} / V_{RRM}$	800	V
$I_{GT}$	$\leq 200$	$\mu A$

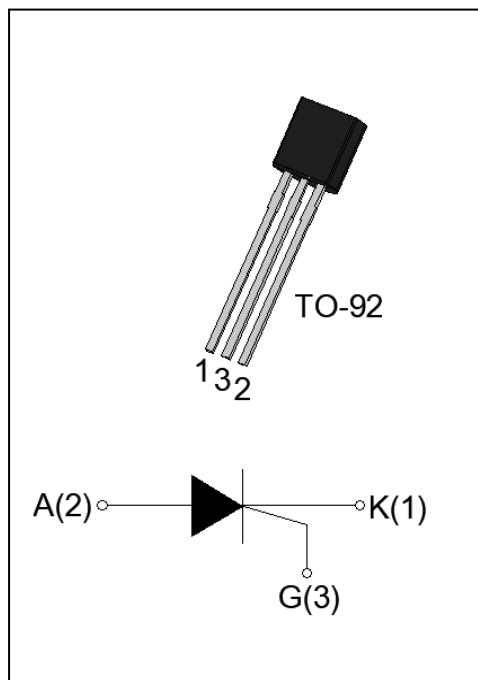

### ABSOLUTE MAXIMUM RATINGS

Parameter	Symbol	Value	Unit
Storage junction temperature range	$T_{stg}$	-40-150	$^{\circ}C$
Operating junction temperature range	$T_j$	-40-125 <sup>①</sup>	$^{\circ}C$
Repetitive peak off-state voltage ( $T_j=25^{\circ}C$ )	$V_{DRM}$	800	V
Repetitive peak reverse voltage ( $T_j=25^{\circ}C$ )	$V_{RRM}$	800	V
Average on-state current ( $T_c \leq 60^{\circ}C$ )	$I_{T(AV)}$	0.5	A
RMS on-state current ( $T_c \leq 60^{\circ}C$ )	$I_{T(RMS)}$	0.8	A
Non repetitive surge peak on-state current ( $t_p=10ms, T_j=25^{\circ}C$ )	$I_{TSM}$	8	A
Non repetitive surge peak on-state current ( $t_p=8.3ms, T_j=25^{\circ}C$ )		9	
$I^2t$ value for fusing ( $t_p=10ms, T_j=25^{\circ}C$ )	$I^2t$	0.32	$A^2s$
Critical rate of rise of on-state current ( $I_G=2 \times I_{GT}, f=100Hz, T_j=125^{\circ}C$ )	$di/dt$	50	$A/\mu s$
Peak gate current ( $t_p=20\mu s, T_j=125^{\circ}C$ )	$I_{GM}$	1	A

Average gate power dissipation ( $T_j=125^\circ\text{C}$ )	$P_{G(AV)}$	0.1	W
Peak gate power	$P_{GM}$	2	W
Peak pulse voltage ( $T_j=25^\circ\text{C}$ ; non-repetitive, off-state; FIG.7)	$V_{pp}$	1	kV

**NOTE 1:** When we parallel connect a  $\leq 1\text{K}\Omega$  resistor between Gate and Cathode, the  $T_j$  can reach  $125^\circ\text{C}$ ; if without this resistor, the  $T_j$  only can reach  $110^\circ\text{C}$ .

### ELECTRICAL CHARACTERISTICS ( $T_j=25^\circ\text{C}$ unless otherwise specified)

Symbol	Test Condition	Value			Unit
		MIN.	TYP.	MAX.	
$I_{GT}$	$V_D=12\text{V } R_L=33\Omega$	-	50	200	$\mu\text{A}$
$V_{GT}$		-	0.6	0.8	V
$V_{GD}$	$V_D=V_{DRM} T_j=125^\circ\text{C}$	0.2	-	-	V
$I_L$	$I_G=1.2 I_{GT}$	-	-	4	mA
$I_H$	$I_T=0.05\text{A}$	-	-	3	mA
dV/dt	$V_D=540\text{V } T_j=125^\circ\text{C } R_{GK}=1\text{K}\Omega$	200	-	-	V/ $\mu\text{s}$
	$V_D=540\text{V } T_j=125^\circ\text{C } R_{GK}=220\Omega$	500	-	-	
$t_{on}$	$I_G=10\text{mA } I_A=20\text{mA } I_R=2\text{mA}$	-	2	-	$\mu\text{s}$
$t_{off}$	$T_j=25^\circ\text{C}$	-	50	-	$\mu\text{s}$

### STATIC CHARACTERISTICS

Symbol	Parameter		Value(MAX.)	Unit
$V_{TM}$	$I_T=1\text{A } t_p=380\mu\text{s}$	$T_j=25^\circ\text{C}$	1.35	V
$V_{TO}$	Threshold voltage	$T_j=125^\circ\text{C}$	0.93	V
$R_D$	Dynamic Resistance	$T_j=125^\circ\text{C}$	0.34	$\Omega$
$I_{DRM}$	$V_D=V_{DRM} V_R=V_{RRM}$	$T_j=25^\circ\text{C}$	2	$\mu\text{A}$
$I_{RRM}$		$T_j=125^\circ\text{C}$	0.2	mA

### THERMAL RESISTANCES

Symbol	Parameter	Value	Unit
$R_{th(j-c)}$	junction to case (DC)	63	$^\circ\text{C}/\text{W}$
$R_{th(j-a)}$	junction to ambient (DC)	140	$^\circ\text{C}/\text{W}$

MARKING

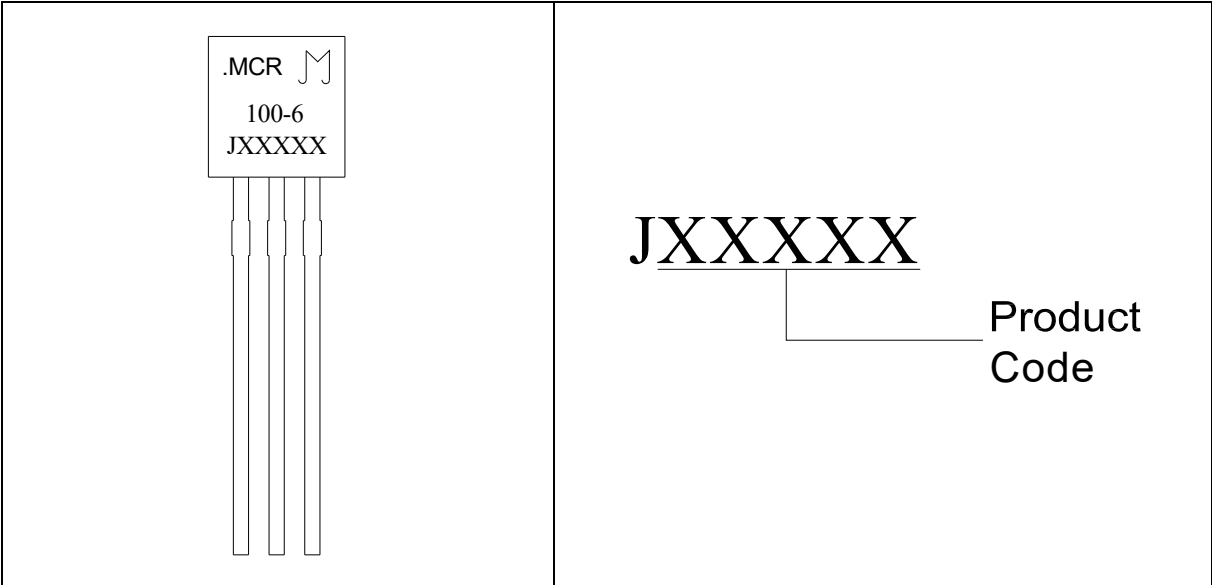

FIG.1 Maximum power dissipation versus RMS on-state current

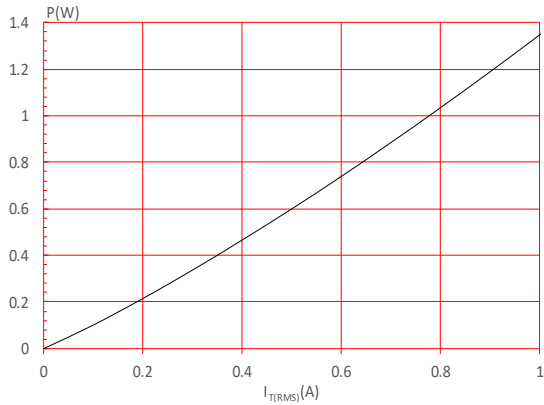

FIG.2: RMS on-state current versus case temperature

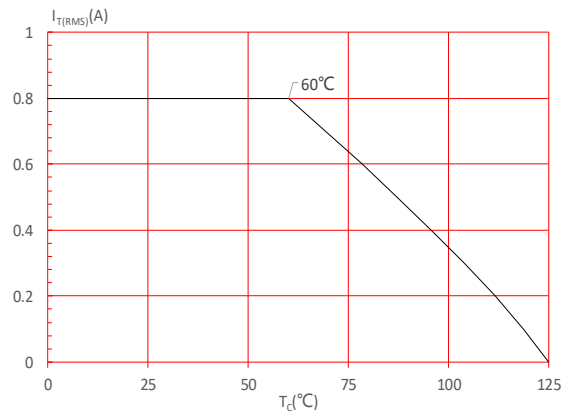

FIG.3: Surge peak on-state current versus number of cycles

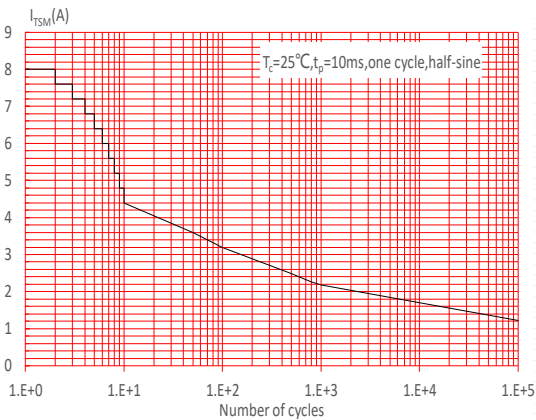

FIG.5: Non-repetitive surge peak on-state current for a sinusoidal pulse with width  $t_p < 10\text{ms}$ , and corresponding value of  $I^2t$  ( $di/dt < 50\text{A}/\mu\text{s}$ )

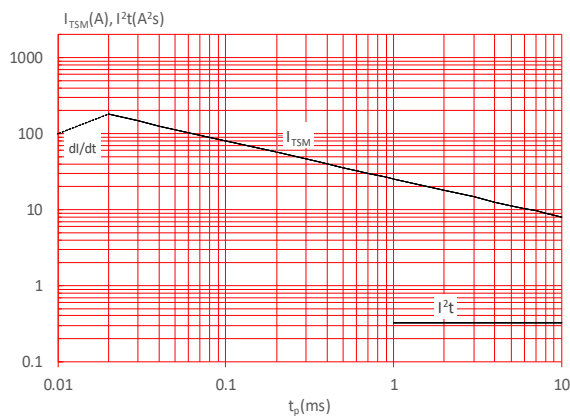

FIG.4: On-state characteristics

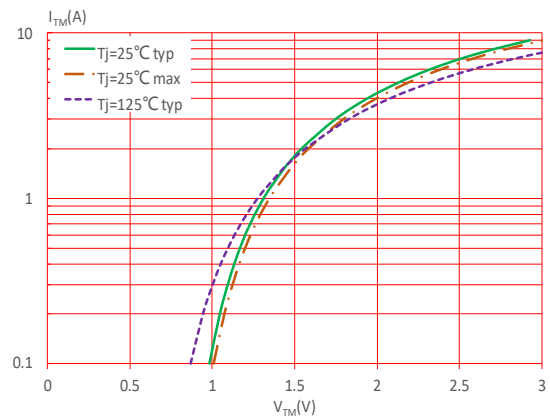

FIG.6: Relative variations of gate trigger current, holding current and latching current versus junction temperature

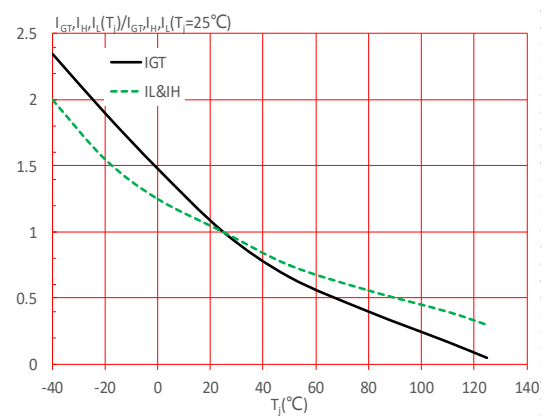
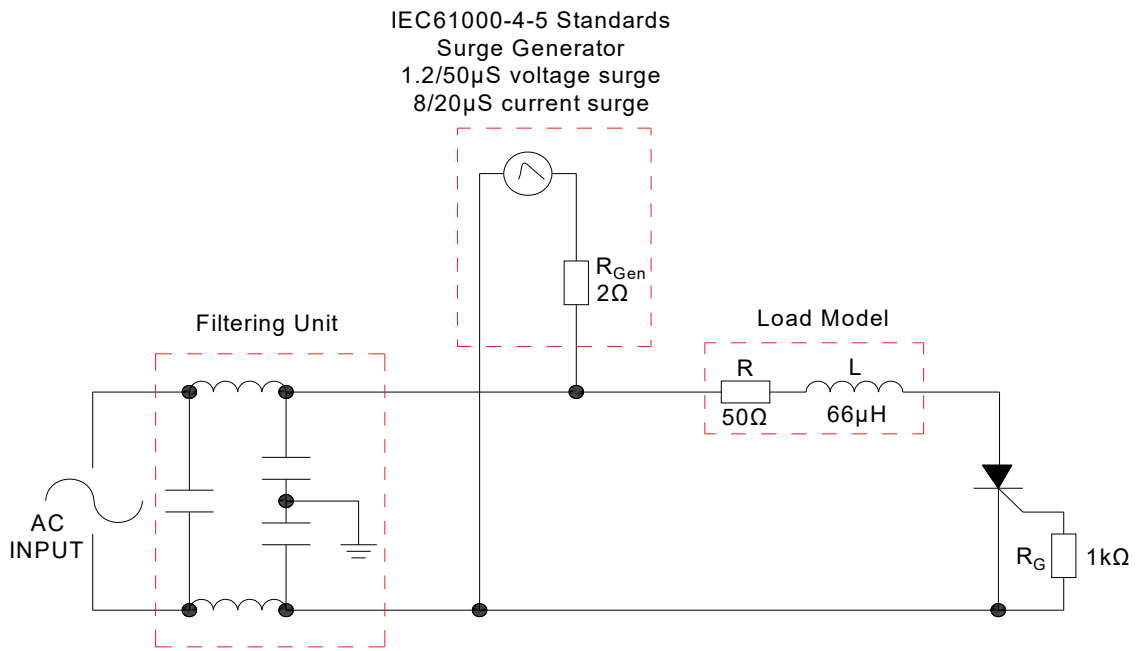

FIG.7: Test circuit for inductive and resistive loads to IEC-61000-4-5 standards.



## SHAPING AND SOLDERING PARAMETERS

Refer to 《Instructions for installation of plastic-sealed in-line power devices》 released by JieJie

**ORDERING INFORMATION**

Order code	Voltage $V_{DRM}/V_{RRM}$ (V)	IGT( $\mu$ A)	Package	Base qty. (pcs)	Delivery mode
MCR100-6	800	$\leq 200$	TO-92	1,000	Bulk Pack
MCR100-6-TR				2,000	Tape & Reel

**Document Revision History**

Date	Revision	Changes
May.23, 2023	A.1.0	Last update

PACKAGE MECHANICAL DATA

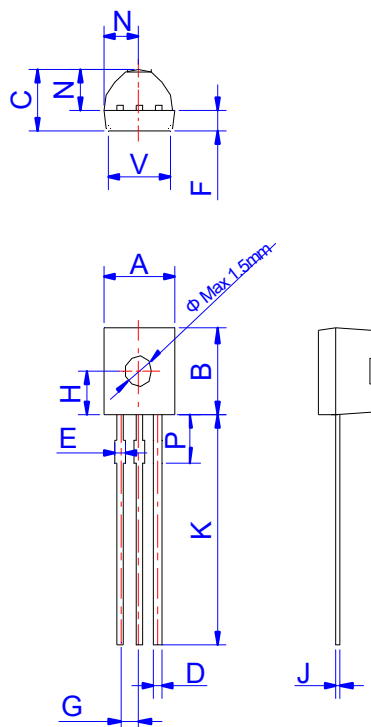

Ref.	Dimensions					
	Millimeters			Inches		
	Min.	Typ.	Max.	Min.	Typ.	Max.
A	4.45		5.20	0.175		0.205
B	4.32		5.33	0.170		0.210
C	3.18		4.19	0.125		0.165
D	0.407		0.533	0.016		0.021
E	0.50		0.70	0.020		0.028
F	1.10		1.30			0.051
G	1.10		1.40	0.043		0.055
H	2.20		2.40	0.087		0.094
J	0.36		0.50	0.014		0.020
K	12.70		15.0	0.500		0.591
N	2.04		2.66	0.080		0.105
P	1.80		2.30	0.071		0.091
V	4.10		4.50	0.161		0.177

DELIVERY MODE

PACKAGE	OUTLINE	BAG (PCS)	INNER BOX (PCS)	CARTON BOX (PCS)
TO-92	Bulk Pack	1,000	10,000	50,000

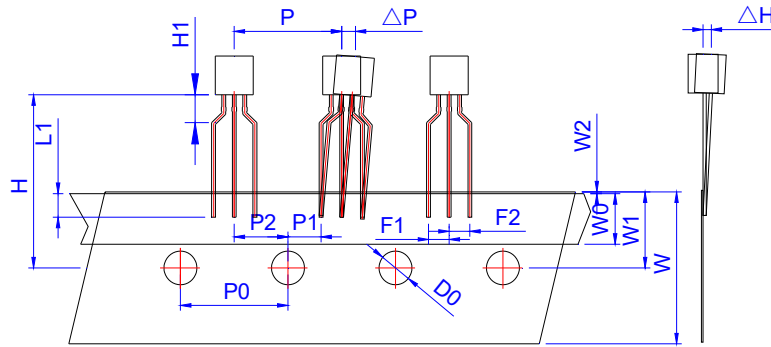

Ref.	Dimensions					
	Millimeters			Inches		
	Min.	Typ.	Max.	Min.	Typ.	Max.
P	12.40	12.70	13.00	0.488	0.500	0.512
P0	12.40	12.70	13.00	0.488	0.500	0.512
P1	3.55	3.85	4.15	0.140	0.152	0.163
P2	5.95	6.35	6.75	0.233	0.250	0.265
ΔP	-1.0	0	1.0	-0.039	0	0.039
F1、F2	2.30	2.50	2.70	0.090	0.098	0.106
F1-F2	-0.1	0	0.1	-0.004	0	0.004
W	17.50	18.00	19.00	0.689	0.709	0.748
W0	5.50	6.00	6.50	0.217	0.236	0.256
W1	8.50	9.00	9.50	0.335	0.354	0.374
W2			1.0			0.039
D0	3.80	4.0	4.20	0.150	0.157	0.165
ΔH	-1.0	0	1.0	-0.039	0	0.039
L1	2.5			0.098		
H	18.0	19.0	20.0	0.709	0.748	0.787
H1			2.70			0.106

PACKAGE	OUTLINE	REEL (PCS)	INNER BOX (PCS)	CARTON BOX (PCS)
TO-92	Tape & Reel	/	2,000	20,000



Information furnished in this document is believed to be accurate and reliable. However, Jiangsu JieJie Microelectronics Co., Ltd. assumes no responsibility for the consequences of use without consideration for such information nor use beyond it. Information mentioned in this document is subject to change without notice, apart from that when an agreement is signed, Jiangsu JieJie complies with the agreement. Products and information provided in this document have no infringement of patents. Jiangsu JieJie assumes no responsibility for any infringement of other rights of third parties which may result from the use of such products and information. This document supersedes and replaces all information previously supplied.

 is a registered trademark of Jiangsu JieJie Microelectronics Co., Ltd.

Copyright © 2023 Jiangsu JieJie Microelectronics Co., Ltd. All rights reserved.